



# 8 SEPARATED 9V POWER BOX



- User Manual
- Mode d'emploi
- Instrukcja obsługi
- Bedienungsanleitung



Dear Customer!

Thank you for choosing our product.

8 SEPARATED 9V POWER BOX (PB-1) is eight outputs adapter to supply guitar effects with 9V direct current (DC). Each of eight outputs is full galvanic separated (isolated from input and others outputs). Separation enables to avoid the ground loops and to obtain 12V and 15V DC voltages by using offered by G LAB adapters and 18V DC voltage by using simple to do cable. Maximal current of each output is 0,35A under the condition of not passing 1A for each section (outputs 1 to 4 and 5 to 8, see the scheme). Each of PB-1 outputs posses short circuit and thermal protection. Outputs No. 4 and 8 posses switches to change voltage polarity.

Thanks to applied in the PB-1 SMPS technology:

- DC output voltage is guaranteed in the range from 100V to 240V line voltage
- there is high output power in proportion to small size and weight
- PB-1 doesn't possesses typical mains transformer which generates electromagnetic field interferences received by other devices situated near to it (e.g. inductors in the wah-wah effect).

### Package content

PB-1 Power Box	1 pc
Mains cable	1 pc
9V 40 cm cable	2 pcs
9V 80 cm cable	4 pcs
9V 120 cm cable	2 pcs
M3 screws	4 pcs
Velcro fastener	4 pairs
Heat shrink tube	10 pcs
Cable label	30 pcs

## Structure

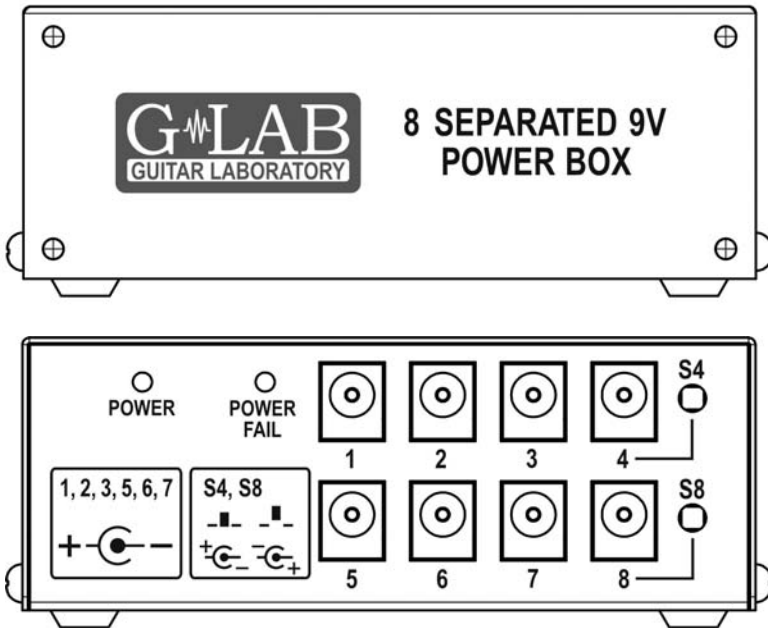

## Mains connecting

PB-1 should be supplied from power outlet equipped with protective contact (so called „protective earth”). It can be supplied from 100V nominal line voltage (Japan), 120V (USA, Canada) and 230V (Europe, Australia). Adapter features power socket according to the IEC320 C14 standard to which is connected the mains cable with a connector appropriate for a given country.

## Connecting to the effects

Before connecting the PB-1 to the effect it is needed to:

- check if the effect should be supplied with DC voltage.  
If so check if it is 9V
- check if the effect features input power supply polarization  
CTR – (center negative)



- check required supply current (if effect can be supplied from 9V battery the supply current check isn't required)

If it the opposite connector polarity is required (CTR +) it is needed to use the output No. 4 (or 8) with changed polarity (diagrams on the box show location of the S4 (or S8) switch and polarity).

**ATTENTION:** Damages caused by improper power supply causes the loss of the warranty. Do not connect the adapter to the effects which need to be supplied from alternating current (AC).

It is recommended to cover the connectors of changed polarity cable with attached labels. The diagrams below explain descriptions on those labels.

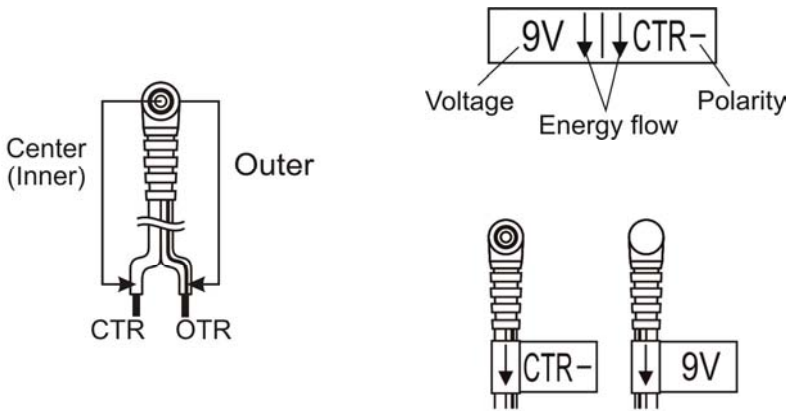

For the effects that require 12V DC voltage it is needed to use individually bought Adapter 2x9V/12V DC (CTR neg. 0,35A) - product code 00865.

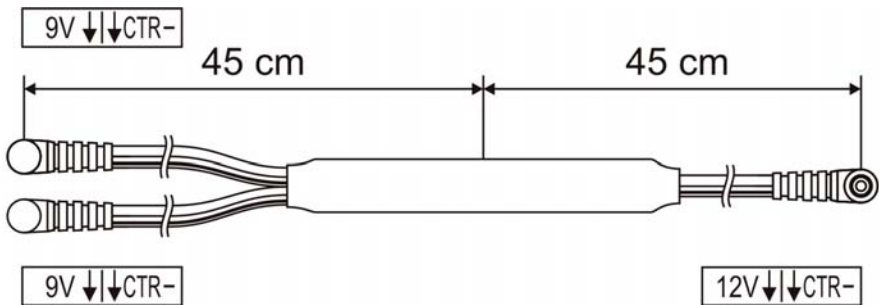

For the effects that require 15V DC voltage it is needed to use individually bought Adapter 2x9V/15V DC (CTR pos. 0,35A) - product code 00866

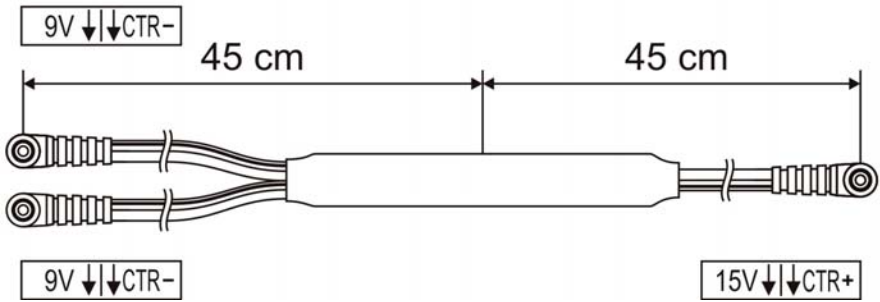

**Persons with qualifications and experiences in electrotechnics can prepare the cables shown below by themselves.**

The packet contains heat shrink tubes and labels for cables with descriptions.

The diagram below shows the cable for the 9V effects with polarity CTR + (center positive) (9V CTR - input, 9V CTR + output).

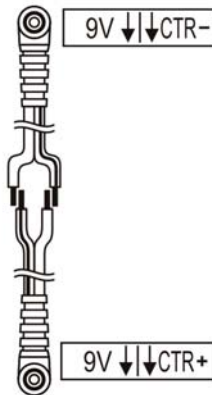

The diagram below shows the cable for the 18V effects with polarity CTR - (center negative) (two 9V CTR - inputs, one 18V CTR - output).

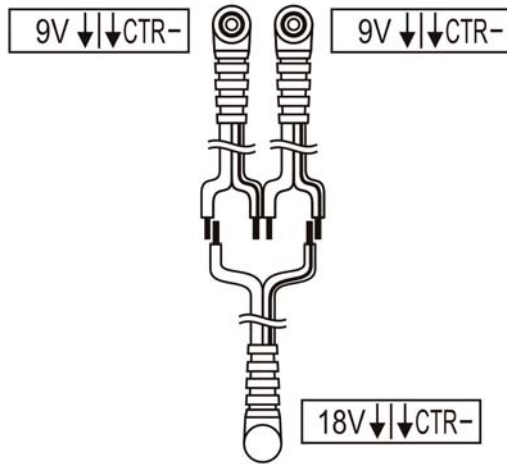

The diagram below shows the cable for supplying the effects requiring 18V DC with polarity CTR + (center positive) (two 9V CTR - inputs, 18V CTR + output).

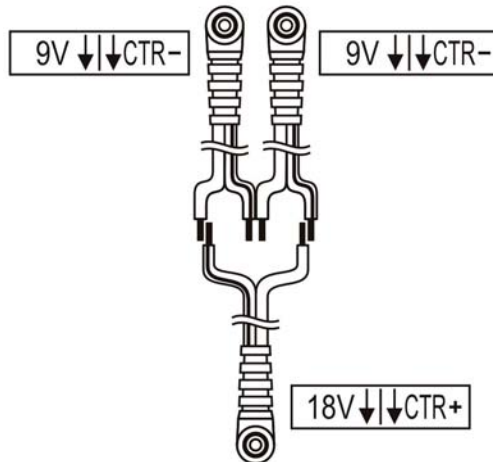

Using separated supply is the basic agent enabling to build the guitar systems without ground loops and supply crosstalk (the influence of variable load of one effect on the second). The best solution is to use separated supply of every effect. The exception from this is possible when the following conditions are met:

- effects are placed in pedalboard or in other place fare from big mains transformers
- the effects are in the same part of the path (e.g. on the effects or before the amp input) and are placed one by one in the signal path
- the effects aren't the overdrive, boost type effects (with high gain) or the effects consume the current impulsively e.g. those equipped with LED display.

The diagram below shows the cable for supplying two 9V effects with polarity CTR - (center negative) from one 9V source (9V CTR - input, two 9V CTR - outputs).

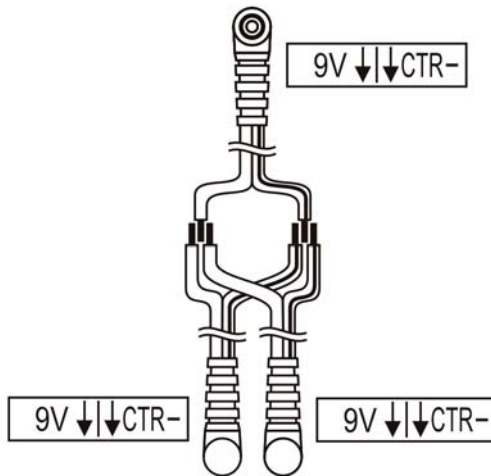

To link the cables you need basic tools and heat shrink tubes (provided with adapter). Strong screwing together the wires and using the heat shrink boot assure reliability and durability of the linking even for three wires.

## Linking wires without soldering

The diagram below shows the way of linking two wires.

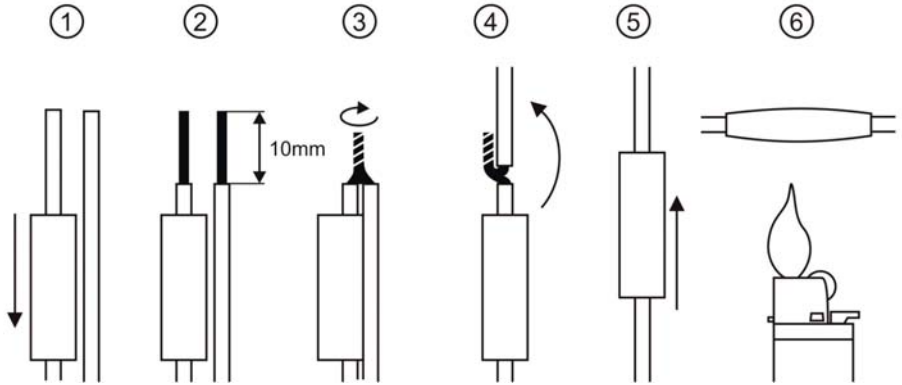

The diagram below shows the way of linking three cables.

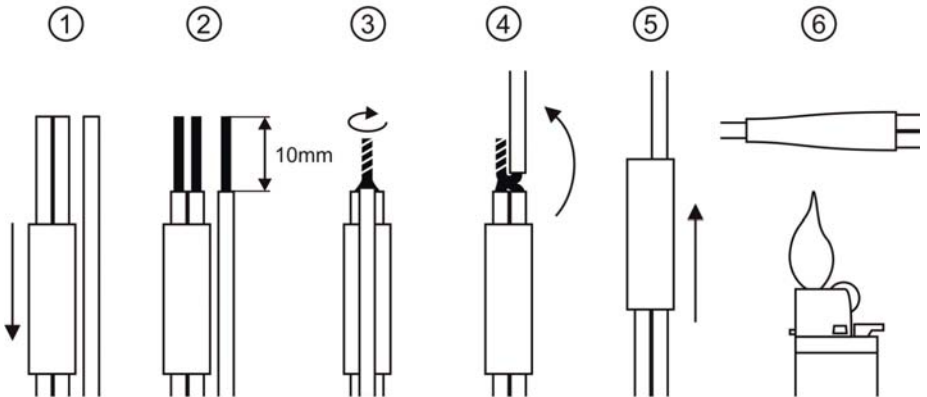

## Mounting

In case of mounting in pedalboard it is possible to use the Velcro fasteners provided with the adapter or to use M4 screw (adapter base posses bushings with M4 threads). The adapter can be also fastened to the rack 19' systems by the use of 1U RMS Panel (product code 00829) and M3 screws supplied with the adapter.

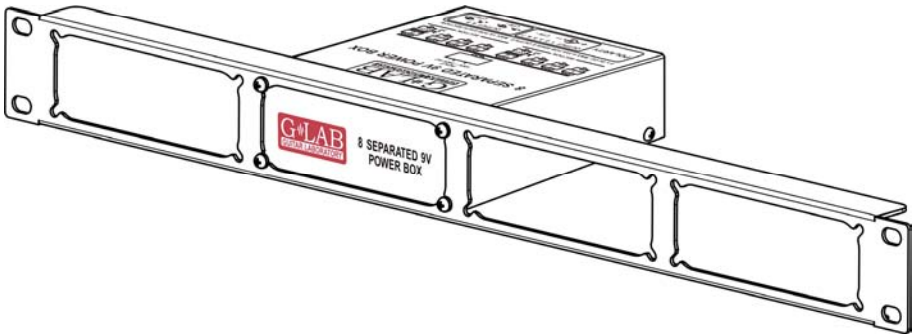

## Technical parameters

Dimensions:	width	108 mm
	Depth	130 mm
	Height	40 mm
Weight		0,9 kg
Power supply nominal		100V - 230V





## FCC Compliance

This device complies with Part 15 of the FCC Rules. Operation is subject to the following two conditions: (1) this device may not cause harmful interference, and (2) this device must accept any interference received, including interference that may cause undesired operation.

**NOTE:** This equipment has been tested and found to comply with the limits for a Class B digital device, pursuant to Part 15 of the FCC Rules. These limits are designed to provide reasonable protection against harmful interference in a residential installation. This equipment generates, uses and can radiate radio frequency energy and, if not installed and used in accordance with the instructions, may cause harmful interference to radio communications. However, there is no guarantee that interference will not occur in a particular installation.

If this equipment does cause harmful interference to radio or television reception, which can be determined by turning the equipment off and on, the user is encouraged to try to correct the interference by one or more of the following measures:

- Reorient or relocate the receiving antenna.
- Increase the separation between the equipment and receiver.
- Connect the equipment into an outlet on a circuit different from that to which the receiver is connected.
- Consult the dealer for help.

### Declaration of Conformity

ELZAB S.A., ul. Kruczkowskiego 39, 41-813 Zabrze, Poland,  
declare under sole responsibility, that the following product:

#### **G LAB/8 SEPARATED 9V POWER BOX (G LAB PB-1)**

conforms with requirements of the EC Council Directives:

- 2006/95/EEC Low Voltage Directive,
- 2004/108/EEC Electromagnetic Compatibility,

and holds CE mark. Above named product conforms with the following standards:

- PN-EN 60065:2004 /EN 60065:2002/ Audio, video and similar apparatus - Safety requirements.
- PN-EN 55103-1:2000 /EN 55103-1:1996/ Electromagnetic compatibility - Product family standard for audio, video, audio-visual and entertainment lighting control apparatus for professional use - Part 1: Emission
- PN-EN 55103-2:2001 /EN 55103-2:1996/ Electromagnetic compatibility - Product family standard for audio, video, audio-visual and entertainment lighting control apparatus for professional use - Part 2: Immunity

Jerzy Biernat

President of the ELZAB S.A. Board of Directors

Copy of original EC declaration of conformity is available for download on our  
website <http://www.glab.com.pl>



**DO NOT PLACE THIS PRODUCT INTO THE WASTE CONTAINER !**

This device is marked with a cross-lined waste container symbol according to 2002/96/EU Directive on Waste Electric and Electronic Equipment.

Such marking informs that after usage equipment can not be trashed together with other household waste.

An user obligation is to return wasted equipment to a party collecting wasted electric and electronic equipment. Parties collecting such equipment organise a system, including local collection points, shops and other units, allowing to return such equipment. This Directive assures an user free of charge utilisation of such delivered equipment.

This device is made of materials which can be recycled or utilised after becoming out of use. Proper handling of wasted electric and electronic equipment reduce demand for raw materials and contribute in avoiding harmful consequences for environment and health of people caused by dangerous components and not proper storing and utilising of such equipment.





[www.glab.com.pl](http://www.glab.com.pl)

G LAB is a brand of ELZAB SA

## COMPANY ADDRESS

### ELZAB SA

ul. Kruczkowskiego 39, 41-813 Zabrze, Poland

phone: +48 32 272 20 21, fax: +48 32 272 81 90

### Sales & Export Department .....

phone: +48 32 272 30 51 ext. 34, 39, 64

+48 32 272 20 21 ext. 308, 366, 468

e-mail: [glab@glab.com.pl](mailto:glab@glab.com.pl)

### Technical Support .....

phone: +48 32 272 30 51 ext. 64

+48 32 272 20 21 ext. 308

e-mail: [help@glab.com.pl](mailto:help@glab.com.pl)